



THE Double Batch™



PERFORMANCE
 The TurboChef® Double Batch™ oven has two independent cavities that circulate impinged air at speeds of up to 50 mph to create high heat transfer rates and reduced cook time. The oven utilizes variable speed blowers, oscillating racks, and catalytic converter, resulting in minimal energy input, high food quality, and ventless operation.

VENTILATION

- UL (KNLZ) listed for ventless operation.†
- EPA 202 test (8 hr):
 - Product: Pepperoni Pizzas
 - Results: 1.04 mg/m³
 - Ventless Requirement: <5.00 mg/m³
- Internal catalytic filtration to limit smoke, grease, and odor emissions.

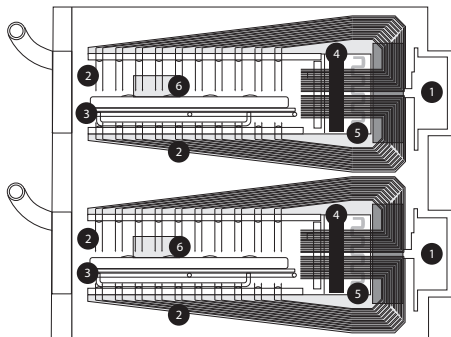

1. Blower Motor
2. Impinged Air
3. Oscillating Rack
4. Catalytic Converter
5. Impingement Heater
6. Xenon Lights

Project _____

Item No. _____

Quantity _____

EXTERIOR CONSTRUCTION

- Stainless steel front, top and sides
- Rubber seal for surface mounting
- 7-inch capacitive touch screen with tempered glass cover

INTERIOR CONSTRUCTION

- 304 stainless steel
- Two fully insulated cook chambers
- Top and bottom jetplates

STANDARD FEATURES

- Simple and intuitive one-touch controls
- Multi-language user interface
- Integral recirculating catalytic converter for UL (KNLZ) listed ventless operation
- Variable-speed High h recirculating air impingement system
- Oscillating rack for high heat transfer without spotting
- Half-sheet pan/16-inch pizza capacity
- Stackable design (requires stacking kit)
- Smart menu system capable of storing unlimited recipes
- Built-in self diagnostics for monitoring oven components and performance
- USB compatible
- Smart Voltage Sensor Technology* (N.A. only)
- Includes plug and cord (6 ft. nominal)
- Warranty – 1 year parts and labor
- Open Kitchen™ ready

CONNECTIVITY PART NUMBERS

- MDD-1001: Initial Equipment
- MDD-1002: Additional Equipment
- MDD-1003: Additional Year (PhD SAAS)



STANDARD ACCESSORIES

- 1 Aluminum Paddle (NGC-1478)
- 1 Bottle Oven Cleaner (105704)
- 1 Bottle Oven Guard (105703)
- 2 Trigger Sprayers (103182)
- 4 Oven Legs (HHB-3205) – Optional



This product conforms to the ventilation recommendations set forth by NFPA96 using EPA202 test method.

* Smart Voltage Sensor Technology does not compensate for lack of or over voltage situations. It is the responsibility of the owner to supply voltage to the unit according to the specifications on the back of this sheet.

† Ventless certification is for all food items except for foods classified as “fatty raw proteins.” Such foods include bone-in, skin-on chicken, raw hamburger meat, raw bacon, raw sausage, steaks, etc. If cooking these types of foods, consult local HVAC codes and authorities to ensure compliance with ventilation requirements.

TurboChef reserves the right to make substitutions of components or change specifications without prior notice.

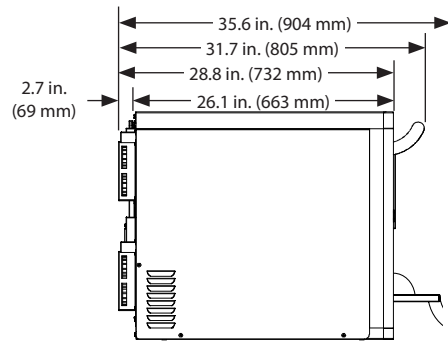
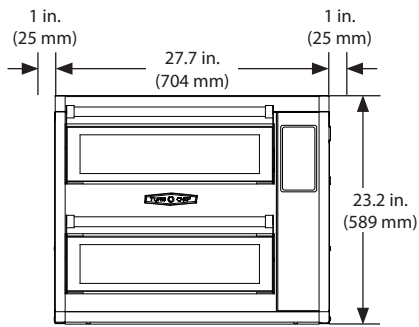

DIMENSIONS		
Single Units		
Height	23.2"	589 mm
Width	27.7"	704 mm
Depth (Door Open/Closed)	35.6" / 31.7"	903 mm / 806 mm
Weight	262 lb.	119 kg
Stacked Units		
Height	46.4"	1,179 mm
Width	27.7"	704 mm
Depth (Door Open/Closed)	31.7" / 35.6"	806 mm / 903 mm
Weight	524 lb.	238 kg
Cook Chamber		
Height	3.3"	84 mm
Width	18.1"	318 mm
Depth	17.07"	434 mm
Volume	0.59 cu.ft.	16.7 liters
Wall Clearance (Oven not intended for built-in installation)		
Top	2"	51 mm
Sides	2"	51 mm
ELECTRICAL SPECIFICATIONS-SINGLE PHASE		
Double Batch US Model (HHD-9500-801) - United States		
Voltage	208/240 VAC	
Frequency	60 Hz	
Current	50 amps	
Max Input	8,320/9,600 watts	
Double Batch UK Model (HHD-9500-802-UK) - International		
Voltage	230 VAC	
Frequency	50 Hz or 60 Hz	
Current	50 amps	
Max Input	8,700 watts	
Double Batch BK Model (HHD-9500-828-BK) - Brazil		
Voltage	220 VAC	
Frequency	60 Hz	
Current	50 amps	
Max Input	8,700 watts	
Double Batch LA Model (HHD-9500-829-LA) - Latin America		
Voltage	220 VAC	
Frequency	60 Hz	
Current	50 amps	
Max Input	8,700 watts	
Double Batch JK Model (HHD-9500-823-JK) - Japan		
Voltage	200 VAC	
Frequency	50 Hz or 60 Hz	
Current	50 amps	
Max Input	8,700 watts	

ELECTRICAL SPECIFICATIONS-3-PHASE		
Double Batch US Model (HHD-9500-814-DL) - United States		
Voltage	208/240 VAC	
Frequency	60 Hz	
Current	30 amps	
Max Input	8,320/9,600 watts	
Double Batch ED Model (HHD-9500-803-ED) - International		
Voltage	230 VAC	
Frequency	50 Hz or 60 Hz	
Current	29 amps	
Max Input	8,700 watts	
Double Batch EW Model (HHD-9500-804-EW) - International		
Voltage	400 VAC	
Frequency	50 Hz or 60 Hz	
Current	20 amps	
Max Input	8,700 watts	
Double Batch AU Model (HHD-9500-811-AU) - International		
Voltage	400 VAC	
Frequency	50 Hz	
Current	20 amps	
Max Input	8,700 watts	
Double Batch JD Model (HHD-9500-824-JD) - Japan		
Voltage	200 VAC	
Frequency	50 Hz or 60 Hz	
Current	29 amps	
Max Input	7,900 watts	
Double Batch LD Model (HHD-9500-831-LD) - Latin America		
Voltage	220 VAC	
Frequency	60 Hz	
Current	29 amps	
Max Input	8,700 watts	
Double Batch BD Model (HHD-9500-832-BD) - Brazil		
Voltage	220 VAC	
Frequency	60 Hz	
Current	29 amps	
Max Input	8,700 watts	
SHIPPING INFORMATION		
U.S.: All ovens shipped within the U.S. are packaged in a double-wall corrugated box banded to a wooden skid. International: All International ovens shipped via Air or Less than Container Loads are packaged in wooden crates.		
Box size: 37" x 36" x 35" (940 mm x 914 mm x 889 mm) Crate size: 39" x 40" x 36" (991 mm x 1016 mm x 914 mm) Item class: 110 NMFC #26710 HS code 8419.81		
Appx. boxed weight: 322 lb. (146 kg) Appx. crated weight: 405 lb. (184 kg)		
Minimum entry clearance required for box: 35.5" Minimum entry clearance required for crate: 39.5"		

TurboChef Global Operations
 2801 Trade Center Drive / Carrollton, Texas 75007 USA
 US: 800.90TURBO (800.908.8726) / International: +1 214.379.6000
 Fax: +1 214.379.6073 / turbochef.com

TurboChef recommends installing a type D circuit breaker for European installations.
 TurboChef reserves the right to substitute components or change specifications without notice.